

# NOVA LUCE

787006

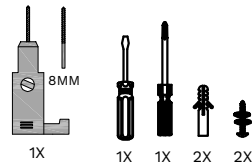

1

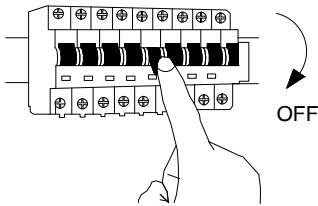

Turn off the general switch

2

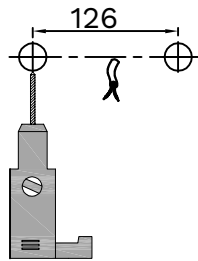

Align Mark & Drill holes

3

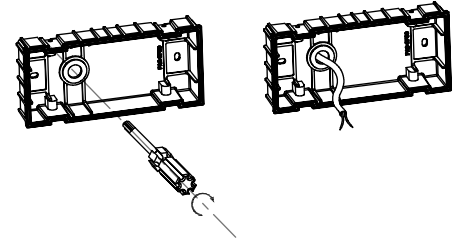

Connect wires

4

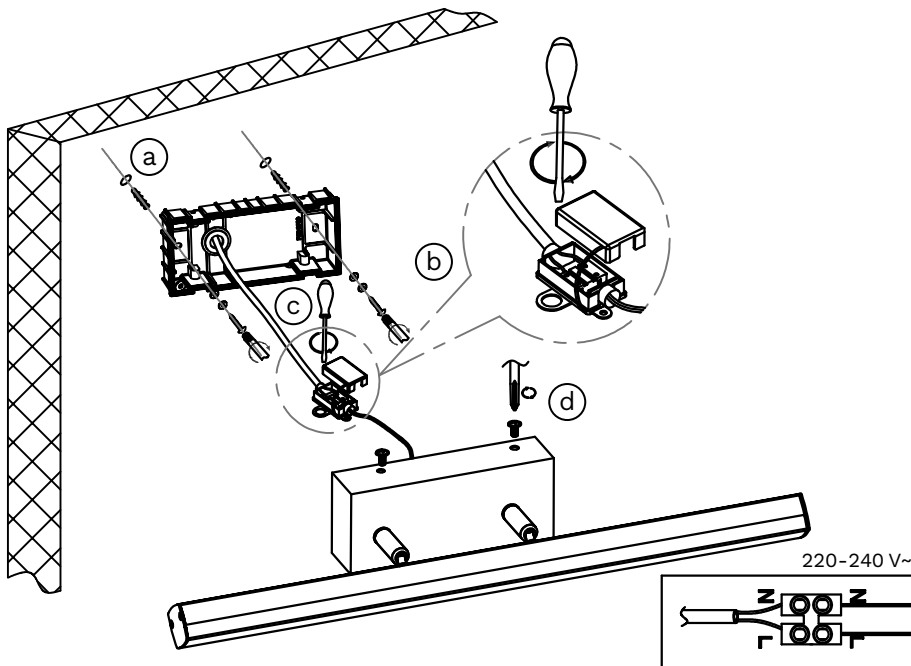

- a. Drill holes, apply plastic anchors
- b. Connect wires
- c. Fix the driver's cap onto place
- d. Apply screws to make luminaire stable

5

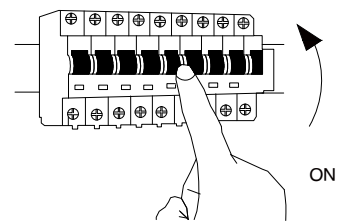

Turn on the general switch

6

ART NR.:787006

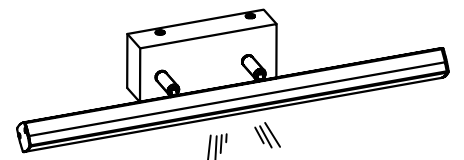

Turn on the light

