

1

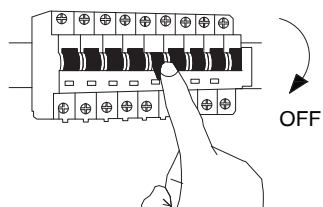

Turn off the general switch

2

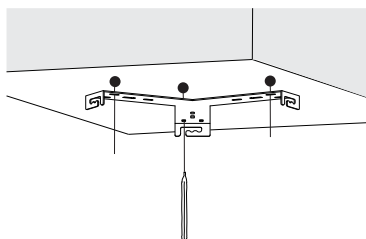

Mark where to drill holes

3

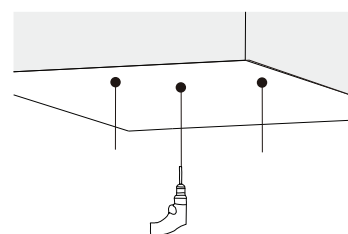

Drill on the marked areas

4

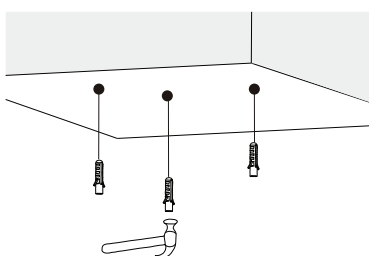

Apply plastic anchors

5

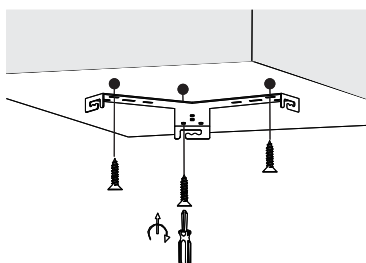

Apply screws

6

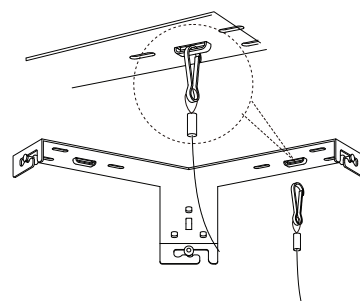

Make it stable

7

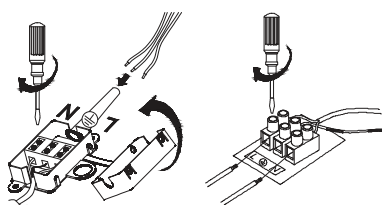

Connect the wires

8

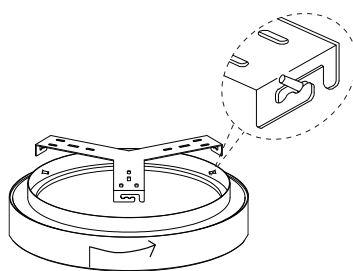

Adjust the wire & fix it into place

9

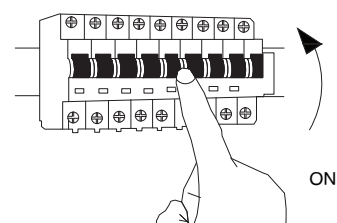

Turn on the general switch

9

