

1

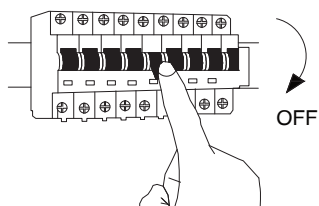

Turn off the general switch

2

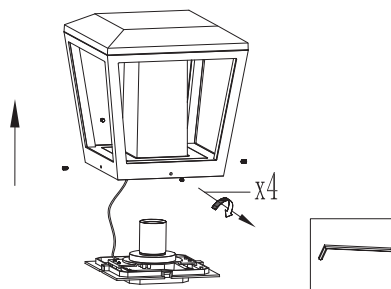

Dismantle parts by untying screws

3

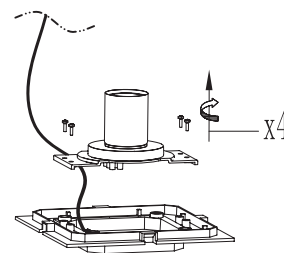

Untie screws

4

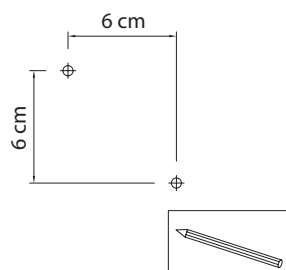

Mark holes

5

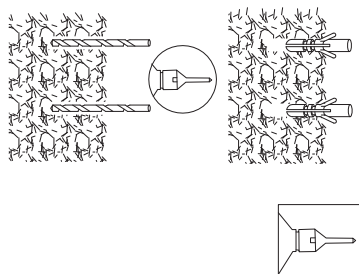

Drill holes & apply plastic anchors

6

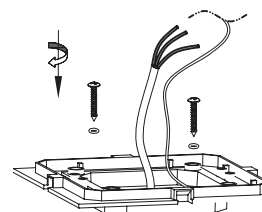

Tie up screws

7

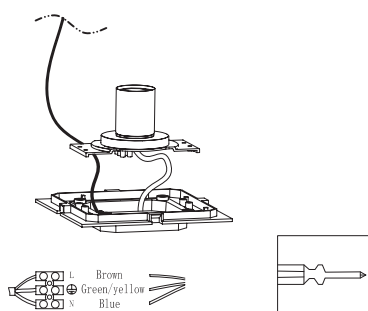

Connect wires

8

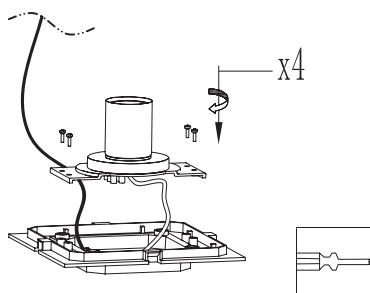

Tie up screws to make it stable

9

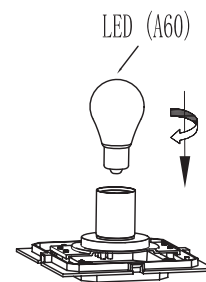

Apply the bulb by rotate

10

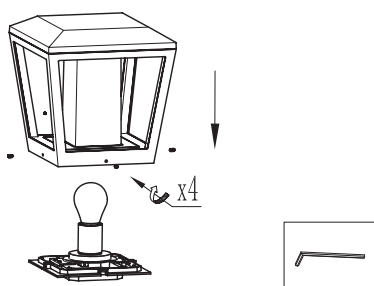

Apply the cap by tying up side screws

11

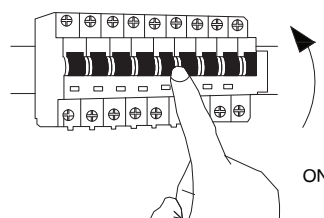

Turn on the general switch

11

