

NOVA LUCE

9030655, 9030656, 9030657

1

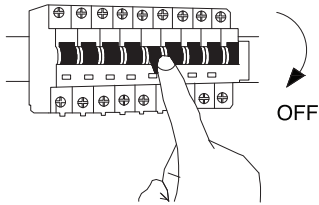

Turn off the general switch

2

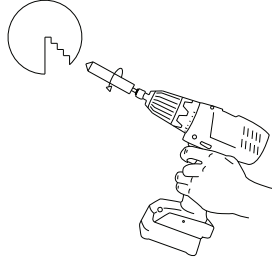

Drill holes

3

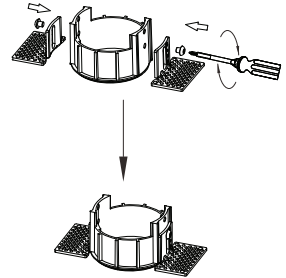

Apply side screws & connect parts

4

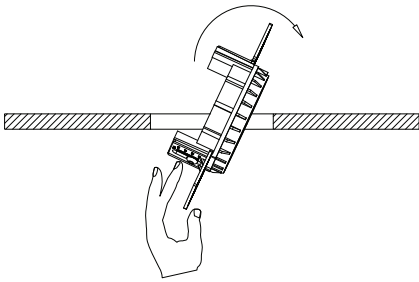

Insert the product into the cutout

5

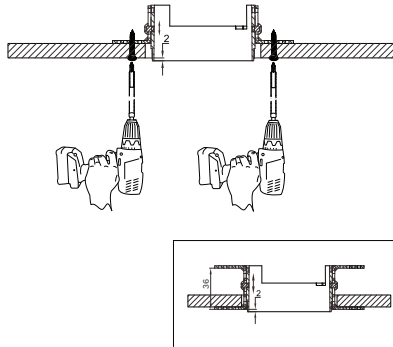

Tie up screws to make it stable

6

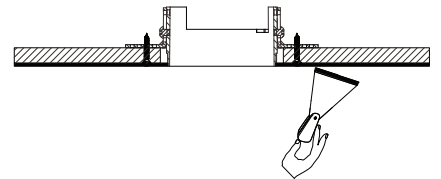

Fix the holes by making it dry

7

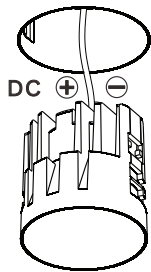

Connect wires

8

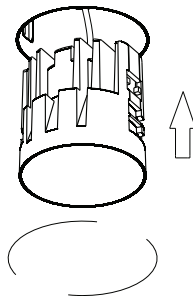

Apply the light by rotating it

9

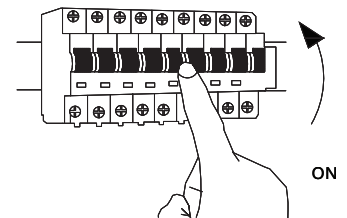

Turn on the general switch



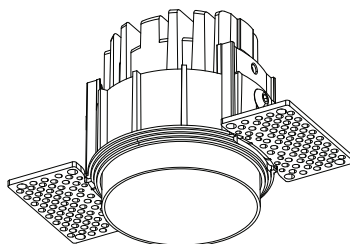

1. The installation must be done by competent electricians
2. Product can not be modified.
3. Make sure the power has been switched off before installation.
4. The product is a class III luminaire and shall be connected with a constant driver according to the specifications in the above sheet.
5. When connecting more than one fixture, these are connecting in series, from plus to minus
6. The specification of the luminaire, should be stranded with 0.5mm²-1.5mm² conductor.
7. The specification for the driver means determines on the voltage and the maximum number of luminaries per loop.
8. Power should never be regulated on the secondary side.
9. See the installations on the image below.

Cutout:  6.8 - 7 cm

