

# NOVA LUCE

9695201

1



Turn off the general switch

2

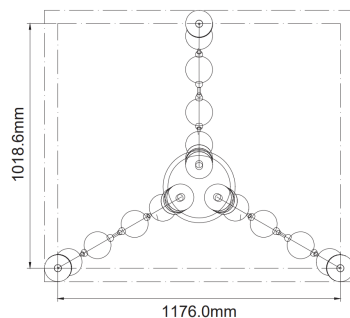

3

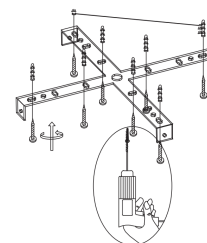

Drill holes apply plastic anchors  
With screws

4

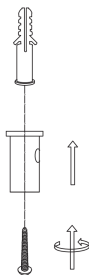

Drill a hole, apply a plastic anchor  
with a screw

5

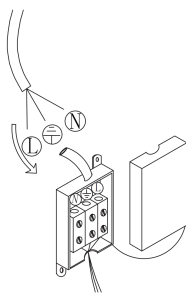

Connect wires

6

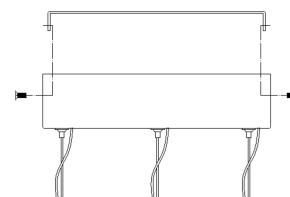

Apply side screws

7

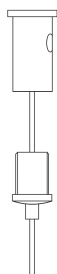

Apply the element in place

8

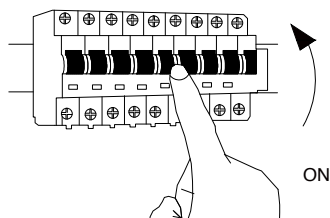

Turn on the general switch

